



# TYPHOON INTAKE SYSTEMS

INTAKE SYSTEMS FOR VEHICLES LISTED ARE 50 STATE LEGAL. SEE KNFILTERS.COM FOR CARB STATUS ON EACH PART FOR A SPECIFIC VEHICLE.

## INSTALLATION INSTRUCTIONS

**69-2005TTK**  
**MINI**  
**2007-11 Cooper**  
**L4-1.6L**

### TOOLS NEEDED:

- Ratchet
- Extension
- 10mm Socket
- Flat Blade Screwdriver
- Pliers
- 10mm Wrench
- T25 Torx
- T30 Torx
- 5/32 Allen Wrench

### PARTS LIST:

Description	Qty.	Part #
A Hose Clamp #44 Stainless	4	08560
B Hose; 2.75" ID Angled 30 Deg.	1	08489
C Intake Tube	1	27471
D Hose; 2-3/4" ID X 2" L	1	08756
E Bolt; M6 X 1.00 X 16MM Bttnhd.	2	07730
F Washer; 6MM Flat, SS	4	08269
G Nut; 6MM Nylock, Hexhead, SS	2	07512
H Heat Shield	1	074066
I Hose Clamp #44	1	08577
J Air Filter	1	RC-5144

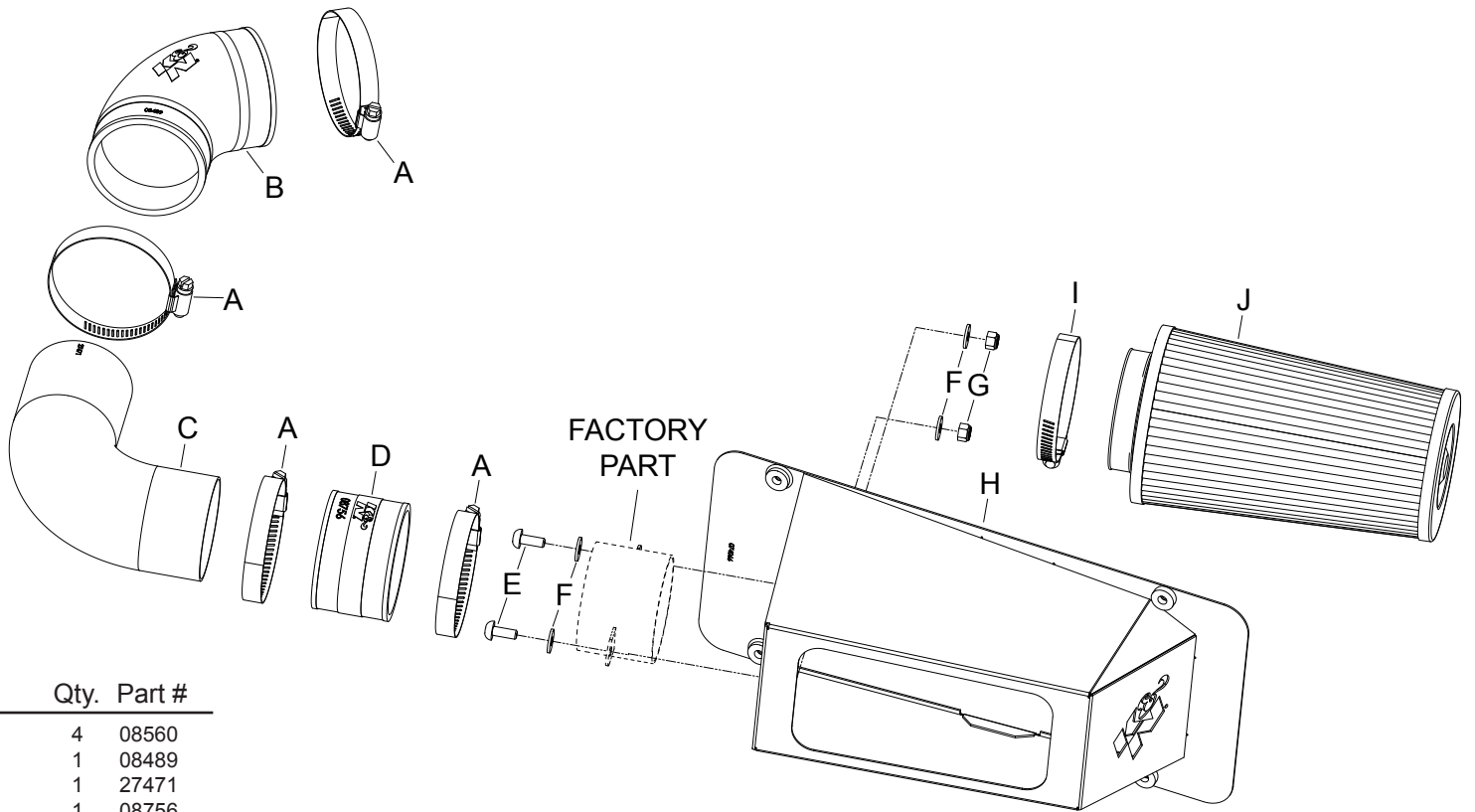

**NOTE: FAILURE TO FOLLOW INSTALLATION INSTRUCTIONS AND NOT USING THE PROVIDED HARDWARE MAY DAMAGE THE INTAKE TUBE, THROTTLE BODY AND ENGINE.**

### TO START:

1. Turn off the ignition and disconnect the negative battery cable.  
**NOTE: Disconnecting the negative battery cable erases pre-programmed electronic memories. Write down all memory settings before disconnecting the negative battery cable. Some radios will require an anti-theft code to be entered after the battery is reconnected. The anti-theft code is typically supplied with your owner's manual. In the event your vehicles' anti-theft code cannot be recovered, contact an authorized dealership to obtain your vehicles anti-theft code.**



2. Release the locking tab and then disconnect the mass air sensor electrical connection.



3. Loosen the hose clamp which secures the intake tube to the mass air sensor.

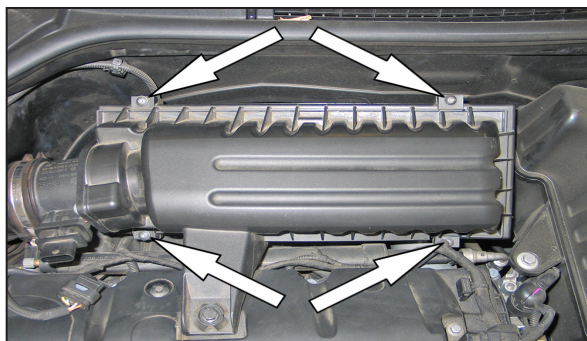

4. Loosen the four screws which secure the upper air box housing to the lower air box housing.

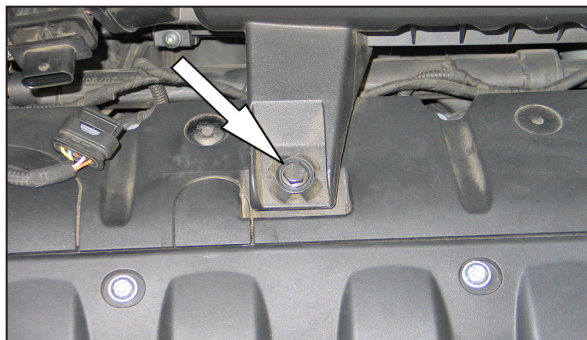

5. Loosen the bolt which secures the upper air box to the valve cover.



6. Remove the upper air box from the vehicle as shown and then remove the stock air filter.



7. Loosen the hose clamp which secures the stock intake hose and then remove the stock intake hose from the vehicle.

**NOTE: K&N Engineering, Inc., recommends that customers do not discard factory air intake.**

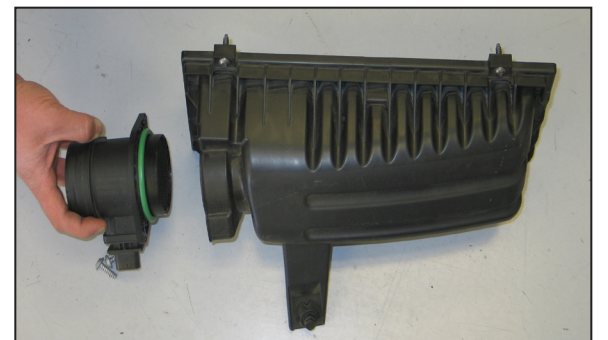

8. Remove the two screws which secure the mass air sensor to the upper air box and then remove the mass air sensor.

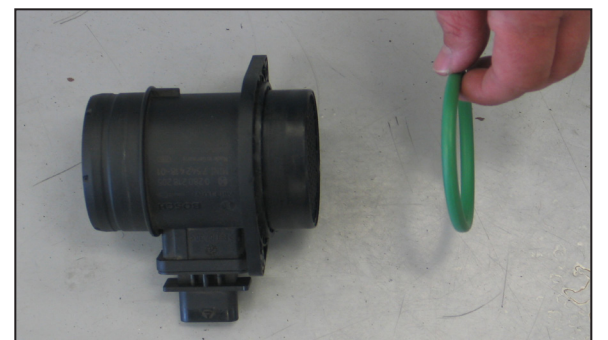

9. Remove the "O" ring from the mass air sensor as shown.

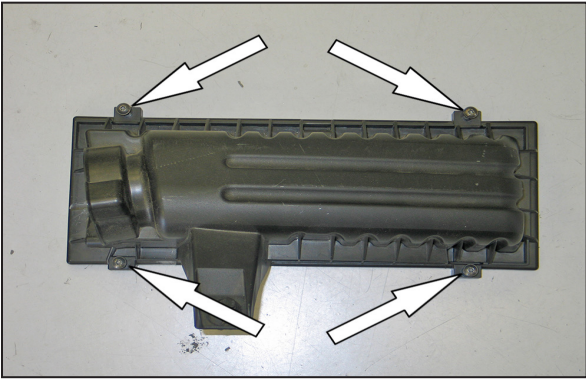

10. Remove the four upper air box retaining screws from the upper air box.

**NOTE: The four upper air box mounting screws will be reused.**



11. Using the provided hardware, secure the factory mass air sensor to the K&N® heat shield as shown.

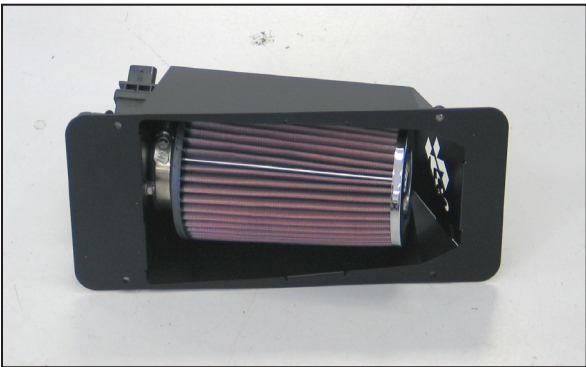

12. Install the K&N® air filter onto the mass air sensor and secure with the provided hose clamp.



13. Secure the provided silicone hose (08489) onto the throttle body and secure with the provided hose clamp.

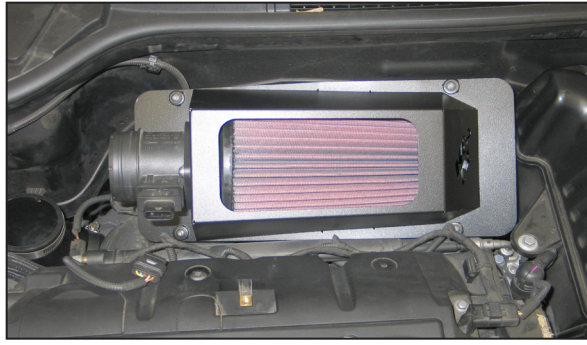

14. Install the heat shield/filter assembly onto the lower air box and secure with the four factory upper air box retaining screws.



15. Install the provided silicone hose (08756) onto the mass air sensor and secure with the provided hose clamp.



16. Install the K&N® intake tube into the silicone hoses and secure with the provided hose clamps.

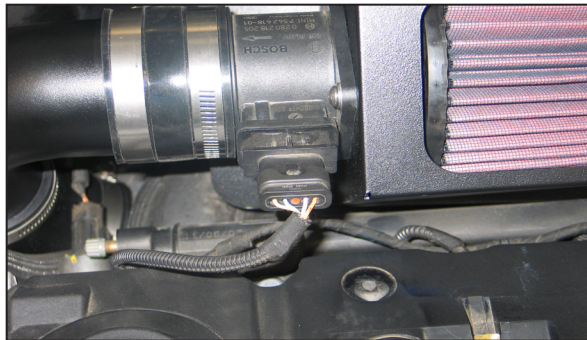

17. Reconnect the mass air sensor electrical connection.



18. Reconnect the vehicle's negative battery cable. Double check to make sure everything is tight and properly positioned before starting the vehicle.

19. The C.A.R.B. exemption sticker, (attached), must be visible under the hood so that an emissions inspector can see it when the vehicle is required to be tested for emissions. California requires testing every two years, other states may vary.

20. It will be necessary for all K&N® high flow intake systems to be checked periodically for realignment, clearance and tightening of all connections. Failure to follow the above instructions or proper maintenance may void warranty.

#### ROAD TESTING:

1. Start the engine with the transmission in neutral or park, and the parking brake engaged. Listen for air leaks or odd noises. For air leaks secure hoses and connections. For odd noises, find cause and repair before proceeding. This kit will function identically to the factory system except for being louder and much more responsive.

2. Test drive the vehicle. Listen for odd noises or rattles and fix as necessary.

3. If road test is fine, you can now enjoy the added power and performance from your kit.

4. K&N Engineering, Inc., requires cleaning the intake system's air filter element every 100,000 miles. When used in dusty or off-road environments, our filters will require cleaning more often. We recommend that you visually inspect your filter once every 25,000 miles to determine if the screen is still visible. When the screen is no longer visible some place on the filter element, it is time to clean it. To clean and re-oil, purchase our filter Recharger® service kit, part number 99-5050 or 99-5000 and follow the easy instructions.

**INTAKE SYSTEMS FOR VEHICLES LISTED ARE 50 STATE LEGAL. SEE KNFILTERS.COM FOR CARB STATUS ON EACH PART FOR A SPECIFIC VEHICLE.**